



probe lockers



probe shelving



probe cupboards



probe mobile shelving



probe heavy duty shelving



probe cloakroom



probe cabinets



probe plastic lockers



Shelving

Solutions for every environment

PROBE SHELVING SYSTEMS



STORMOR

DUO

- **Shelf Material**
Steel
- **Shelf Adjustability**
25mm pitch on clips
- **Configuration**
Static or Mobile
- **Frame Type**
Clad
- **Bay Type**
Open or Clad
- **Max. Shelf Load UDL***
Up to 130kg*
- **Max. Bay Load UDSWL***
Up to 1,000kg*
- **Dimensions**
18 heights:
From 950mm to 3500mm
12 depths:
From 200mm to 600mm
8 widths*:
From 600mm to 1250mm
- **Upright Colour**
White or Light Grey
- **Shelf Colour**
White or Light Grey
- **ActiveCoat**
Light Grey only
- **Accessories Available**
Part Height Divider
Full Height Divider
Lateral Filing Cradle
Pull-out Filing Cradle
Pull-out Reference Shelving
Pull-out Drawers
Full Height Doors
Plastic Drawer/Bins
Cladding

4-15

MONO

- **Shelf Material**
Steel
- **Shelf Adjustability**
25mm pitch on clips
- **Configuration**
Static or Mobile
- **Frame Type**
Open
- **Bay Type**
Open or Clad
- **Max. Shelf Load UDL***
Up to 130kg*
- **Max. Bay Load UDSWL***
Up to 1,000kg*
- **Dimensions**
18 heights:
From 950mm to 3500mm
12 depths:
From 200mm to 600mm
8 widths*:
From 600mm to 1250mm
- **Upright Colour**
White or Light Grey
- **Shelf Colour**
White or Grey
- **ActiveCoat**
Light Grey only
- **Accessories Available**
Part Height Divider
Full Height Divider
Lateral Filing Cradle
Pull-out Filing Cradle
Pull-out Reference Shelving
Pull-out Drawers
Full Height Doors
Plastic Drawer/Bins
Cladding
Mesh Frame Cladding

SOLO

- **Shelf Material**
Steel
- **Shelf Adjustability**
25mm pitch on clips
- **Configuration**
Static or Mobile
- **Frame Type**
Clad
- **Bay Type**
Open or Clad
- **Max. Shelf Load UDL***
Up to 130kg*
- **Max. Bay Load UDSWL***
Up to 700kg*
- **Dimensions**
18 heights:
From 950mm to 3500mm
12 depths:
From 200mm to 600mm
8 widths*:
From 600mm to 1250mm
- **Upright Colour**
White or Light Grey
- **Shelf Colour**
White or Grey
- **ActiveCoat**
Light Grey only
- **Accessories Available**
Part Height Divider
Full Height Divider
Lateral Filing Cradle
Pull-out Filing Cradle
Pull-out Reference Shelving
Pull-out Drawers
Full Height Doors
Plastic Drawer/Bins
Cladding

KINETIC 2+

MOBILE

- **Material**
Steel
- **Shelf Adjustability**
NA
- **Configuration**
Track or Trackless
- **Frame Type**
Mobile
- **Bay Type**
NA
- **Max. Load UDL***
Up to 20,000kg*
- **Max. Bay Load UDL***
Up to 1,000kg*
- **Dimensions**
Height: based on shelving plus
height of mobile base
& track
Depth: to suit shelving
Width: to suit runs of shelving
- **Colour**
White or light grey
- **Shelf Colour**
Dependent on system chosen
- **ActiveCoat**
Light Grey only
- **Accessories Available**
N/A

16-21

STOCKRAX

STANDARD

- **Shelf Material**
18mm chipboard on
Steel Beams
- **Shelf Adjustability**
38mm pitch on beams
- **Configuration**
Static
- **Frame Type**
Open
- **Bay Type**
Open
- **Max. Shelf Load UDL***
Up to 360kg*
- **Max. Bay Load UDL***
Up to 2000kg*
- **Dimensions**
2 heights:
1981 & 2438mm
3 depths:
300, 450 & 600mm
3 widths:
900, 1200 & 1500mm
- **Upright Colour**
Blue, Red, Light or
Graphite Grey
- **Shelf Colour**
Light Grey Beams
- **ActiveCoat**
Light Grey only

22-25

HEAVY DUTY

- **Shelf Material**
18mm chipboard on
Steel Beams
- **Shelf Adjustability**
38mm pitch on beams
- **Configuration**
Static
- **Frame Type**
Open
- **Bay Type**
Open
- **Max. Shelf Load UDL***
Up to 650kg*
- **Max. Bay Load UDL***
Up to 3000kg*
- **Dimensions**
2 heights:
1981 & 2438mm
3 depths:
450, 600 & 900mm
6 widths:
900 - 2400mm
- **Upright Colour**
Blue, Red, Light or
Graphite Grey
- **Shelf Colour**
Light Grey Beams
- **ActiveCoat**
Light Grey only

LONGSPAN

INDUSTRIAL

- **Shelf Material**
Chipboard or Galvanised
Steel Panels on Steel Beams
- **Shelf Adjustability**
50mm pitch on beams
- **Configuration**
Static, Mobile or Tiered
- **Frame Type**
Open, Mesh or Clad
- **Bay Type**
Back type open
- **Max. Shelf Load UDL***
Up to 1800kg*
- **Max. Bay Load UDL***
Up to 6800kg*
- **Dimensions**
20 heights between:
1200 - 4050mm
6 depths between:
450 - 1200mm
14 widths between:
1050 - 3000mm
- **Upright Colour**
Graphite Grey,
Light Grey
- **Shelf Colour**
Light Grey Beams
- **ActiveCoat**
Light Grey only

26-29

EUROSHELVING

INDUSTRIAL

- **Shelf Material**
Steel
- **Shelf Adjustability**
50mm pitch on clips
- **Configuration**
Static, Mobile or Tiered
- **Frame Type**
Open, Clad or Mesh
- **Bay Type**
Open, Clad or Mesh
- **Max. Shelf Load UDL***
Up to 350kg*
- **Max. Bay Load UDL***
Up to 5500kg*
- **Dimensions**
18 heights between:
1200 - 3600mm
8 depths between:
250 - 900mm
4 widths between:
900 - 1250mm
- **Upright Colour**
Light or Graphite Grey,
Blue
- **Shelf Colour**
Light Grey
- **ActiveCoat**
Light Grey only
- **Accessories Available**
Part Height Divider
Full Height Divider
Bin Fronts
Pull-out Reference Shelf
Pull-out Drawer
Pull-out Filing Cradle
Hanging Garment Rail
Half & Full Height Doors

30-33

*Depending on specification





DUO UPRIGHT



SOLO UPRIGHT



MONO UPRIGHT

STORMOR SHELVING - A TRULY INTEGRATED SYSTEM



This shelving system is an evolution of our best selling Mistral shelving. The shelving accessories are fully compatible, excluding door sets as the shelving heights have been optimised for efficient storage of contemporary products.

maximum bay loading:
1,000kg*



STORMOR DUO

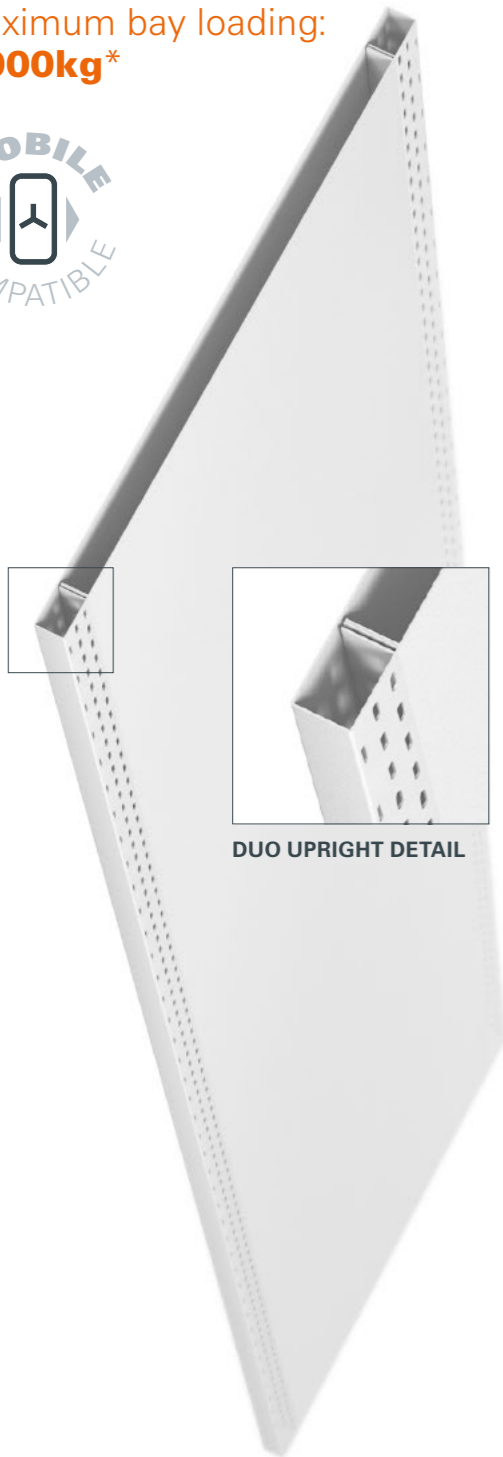

DUO UPRIGHT DETAIL

maximum bay loading:
700kg*



STORMOR SOLO



SOLO UPRIGHT DETAIL

maximum bay loading:
1,000kg*



STORMOR MONO

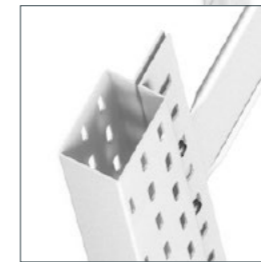
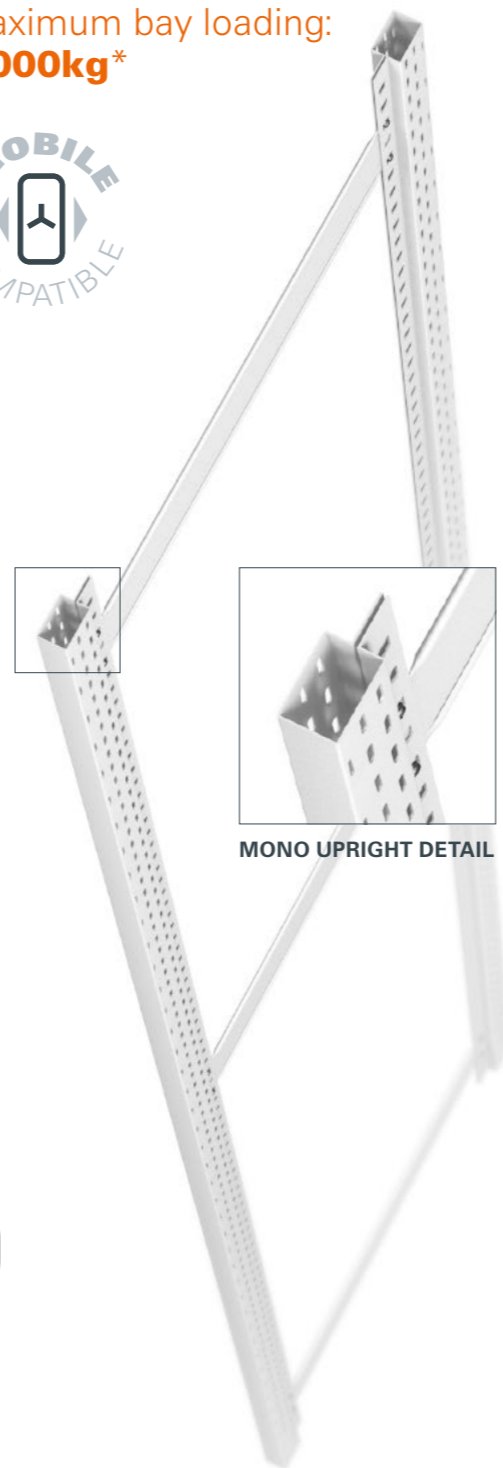

MONO UPRIGHT DETAIL

ACCESSORIES



BOX SHELF AND OPEN SHELF†

Available in several load duties for varying load applications. With many widths and depths available, this system is extremely versatile. The open shelf is even compatible with hanging files.



PULL OUT SHELF

These Pull Out Shelves offer quick and convenient access to many items and can be utilised as a retractable work surface. Available for 1000wide bays. Three depths available. Max 20kg per pull out shelf.



PULL OUT CRADLE†

This Pull Out Cradle is designed to give easy access to stored hanging files and is available for 1000mm wide bays and is available in three depths: 370mm, 400mm & 450mm.

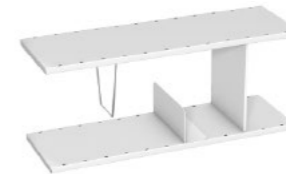

DIVIDERS

A huge range of Full Height, Part Height and Under-Shelf Dividers are available, see technical literature for all options.



PULL OUT DRAWER

Fitted onto telescopic arms, these pull out draws are available in three heights and three depths. Internal dividers are available.



DOOR SETS

Door sets allow bays to be used as lockable cupboards. Available in several heights and widths. Compatible with pull-out accessories.

*Dependent on specification

Probe reserve the right to alter design and price without prior consent.

STORMOR DUO SHELVING

Features & benefits

- o Ideal for **office, store room** or even **warehouse**
- o Shelves are clipped in position for **quick assembly**
- o A **stylish** and **adaptive** shelving system
- o **Extension bays** can be added very quickly and simply
- o **Compatible with all Stormor uprights**
- o **Many sizes available** to suit your storage needs



DOOR SETS

Door sets allow bays to be used as lockable cupboards. These are available in several heights and widths and are compatible with pull-out accessories.



PULL OUT CRADLE†

This Pull Out Cradle is designed to give easy access to stored hanging files and is available for 1000mm wide bays and is available in three depths: 370mm, 400mm & 450mm

STYLISH

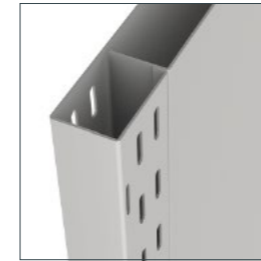

DUO UPRIGHT

AVAILABLE COLOURS

- GREY
RAL 7035
- WHITE
RAL 9016



18 HEIGHTS AVAILABLE
From 950mm to a towering 3500mm

18 HEIGHTS AVAILABLE

From 950mm to a towering 3500mm

12 DEPTHS

From 200mm to 600mm

8 WIDTHS*

*Not all accessories are available in all widths.



BOX SHELF

Available in three load duties for varying load applications. With four widths and eight depths available, this system is extremely versatile.



OPEN SHELF†

A multi-purpose shelf with two load duties and many widths and depths available. An open flange design makes this shelf compatible with hanging files.



PULL OUT SHELF

Offering convenient access to and can be utilised as a retractable work surface. Available for 1000mm wide bays. Three depths available. Max 20kg per pull out shelf.

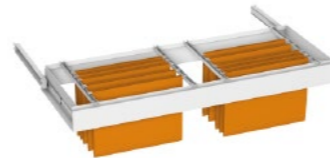

PULL OUT CRADLE†

This Pull Out Cradle is designed to give easy access to stored hanging files and is available for 1000mm wide bays and is available in three depths: 370mm, 400mm & 450mm.



PLASTIC DRAWER UNITS

Ideal for separating small components, these easy access cantilever drawers come in three convenient sizes. Draw dividers also available.



PULL OUT DRAWER

Fitted onto telescopic arms, these pull out draws are available in three heights and three depths. Internal dividers are available.

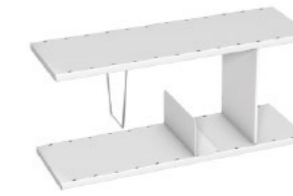

DIVIDERS

A huge range of Full Height, Part Height and Under-Shelf Dividers are available, see technical literature for all options.



DOOR SETS

Door sets allow bays to be used as lockable cupboards. Available in several heights and widths. Compatible with pull-out accessories.

STORMOR MONO SHELVING

Features & benefits

- o Ideal for **store room** or even **warehouse**
- o Shelves are clipped in position for **quick assembly**
- o A **stylish** and **adaptive** shelving system
- o **Extension bays** can be added very quickly and simply
- o **Compatible with all Stormor uprights**
- o **Many sizes available** to suit your storage needs



MESH FRAME CLADDING

These pre-galvanised Mesh Panels are perfect for separating stored items while allowing full vis-ability and ventilation.



GARMENT HANGING RAIL

A choice of two rail diameters available. The rails are re positionable in the available slots.

FLOOR FIXINGS AVAILABLE

See technical literature.

ECONOMICAL

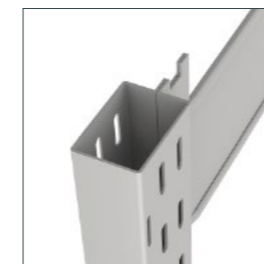

MONO UPRIGHT

AVAILABLE COLOURS

- GREY
RAL 7035
- WHITE
RAL 9016

18 HEIGHTS AVAILABLE

From 950mm to a towering 3500mm

12 DEPTHS

From 200mm to 600mm

8 WIDTHS*

*Not all accessories are available in all widths.



18 HEIGHTS AVAILABLE
From 950mm to a towering 3500mm



BOX SHELF

Available in three load duties for varying load applications. With four widths and eight depths available, this system is extremely versatile.



OPEN SHELF†

A multi-purpose shelf with two load duties and many widths and depths available. An open flange design makes this shelf compatible with hanging files.



PULL OUT SHELF

Offering convenient access to and can be utilised as a retractable work surface. Available for 1000mm wide bays. Three depths available. Max 20kg per pull out shelf.

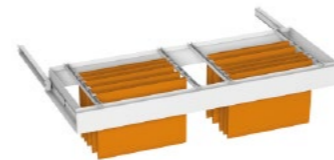

PULL OUT CRADLE†

This Pull Out Cradle is designed to give easy access to stored hanging files and is available for 1000mm wide bays and is available in three depths: 370mm, 400mm & 450mm.



PLASTIC DRAWER UNITS

Ideal for separating small components, these easy access cantilever drawers come in three convenient sizes. Draw dividers also available.



PULL OUT DRAWER

Fitted onto telescopic arms, these pull out draws are available in three heights and three depths. Internal dividers are available.

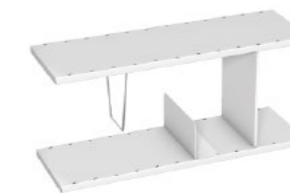

DIVIDERS

A huge range of Full Height, Part Height and Under-Shelf Dividers are available, see technical literature for all options.



DOOR SETS

Door sets allow bays to be used as lockable cupboards. Available in several heights and widths. Compatible with pull-out accessories.

STORMOR SOLO SHELVING

Features & benefits

- Ideal for **office, store room** or even **warehouse**
- Shelves are clipped in position for **quick assembly**
- A **stylish** and **adaptive** shelving system
- **Extension bays** can be added very quickly and simply
- **Compatible with all Stormor uprights**
- **Many sizes available** to suit your storage needs



PRACTICAL PRACTICAL

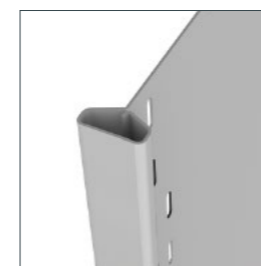

SOLO UPRIGHT

AVAILABLE COLOURS

- GREY
RAL 7035
- WHITE
RAL 9016



18 HEIGHTS AVAILABLE

From 950mm to a towering 3500mm

12 DEPTHS

From 200mm to 600mm

8 WIDTHS*

*Not all accessories are available in all widths.



BOX SHELF

Available in three load duties for varying load applications. With four widths and eight depths available, this system is extremely versatile.



OPEN SHELF†

A multi-purpose shelf with two load duties and many widths and depths available. An open flange design makes this shelf compatible with hanging files.



PULL OUT SHELF

Offering convenient access to and can be utilised as a retractable work surface. Available for 1000mm wide bays and is available in three depths available. Max 20kg per pull out shelf.

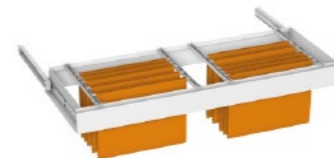

PULL OUT CRADLE†

This Pull Out Cradle is designed to give easy access to stored hanging files and is available for 1000mm wide bays and is available in three depths: 370mm, 400mm & 450mm.



PLASTIC DRAWER UNITS

Ideal for separating small components, these easy access cantilever drawers come in three convenient sizes. Draw dividers also available.



PULL OUT DRAWER

Fitted onto telescopic arms, these pull out draws are available in three heights and three depths. Internal dividers are available.

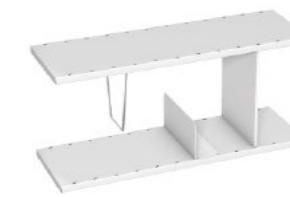

DIVIDERS

A huge range of Full Height, Part Height and Under-Shelf Dividers are available, see technical literature for all options.



DOOR SETS

Door sets allow bays to be used as lockable cupboards. Available in several heights and widths. Compatible with pull-out accessories.



KINETIC 2+ HIGH DENSITY MOBILE SYSTEM

KINETIC 2+ MOBILE BASE SYSTEM

This comprehensive Mobile Base System from Probe offers the highest quality track, mechanism and base. Design to create up to 100% more storage space in your existing archive area. Pictured here with Stormor Duo.

UP TO **100%**
**SPACE
SAVING**



ENGINEERED EFFICIENCY

- No floor fixings option for **easy installation** and re location
- **Double your storage** space quickly and simply
- **Five track/floor options** to suit your environment
- Mobile base system is **easily extended or re located**
- **Smooth light action even on heavy loads**
- **Quality engineered** to provide a sturdy and robust mobile system

LIGHT DUTY - 750kg UDL*

The **750kg** UDL* base load make these ideal for retail stockrooms, offices and medical practices.

MEDIUM DUTY - 5,000kg UDL*

Perfect for the storage of live files, small archives, artefacts, healthcare and industrial items. Base load of up to **5,000kg** UDL.

HEAVY DUTY - 20,000kg UDL*

With a base load of up to **20,000kg** UDL* these are ideal for off-site archives and engineering stores.

*Uniformly Distributed Load.

System shown is for illustrative purposes only and may differ depending on duty requirements. Probe reserve the right to alter design and price without prior consent.



FLAT FLOORS SURFACE PROFILE TRACK

A simple, quick to install and cost effective system for flat floors. Aluminium extruded ramp with steel inset is fixed directly onto the floor and is suitable for floors with a flatness of between 1mm and 3mm/1000mm, in all directions, depending on application. A typical application would be a raised floor in an office.

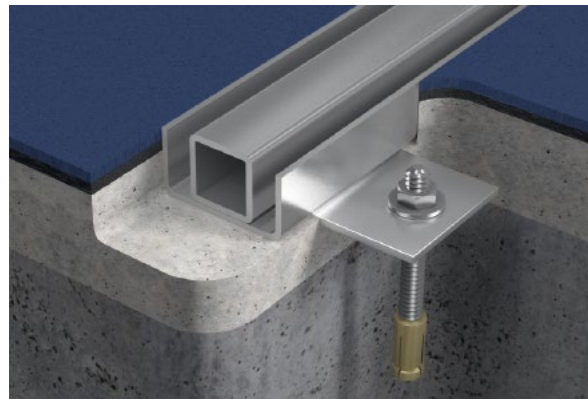

NEW FLOORS IN-SITU TRACK

No ramps are required for this system making it ideal for wheeled traffic. Suitable for new buildings where the final finished floor surface has not been laid. The track is levelled and fixed using nuts above and below the foot plate. For existing floors channels 200mm wide x 50mm deep can be used (subject to floor suitability).

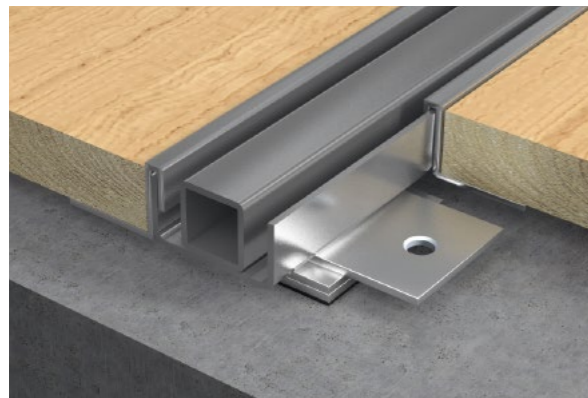

UNEVEN FLOORS INFILL FLOOR TRACK

Suitable for floors with an average flatness of 15mm over the floor. Floors are shimmed but not fixed preventing any need to put holes into the existing floor allowing easy relocation at a later date. An infill floor is fitted, ensuring a smooth trip free floor surface between tracks. Alternative finishes can be supplied. Ramps and trim are fitted to all edges of the floor.



UNEVEN FLOORS INFILL FLOOR TRACK - FIXED

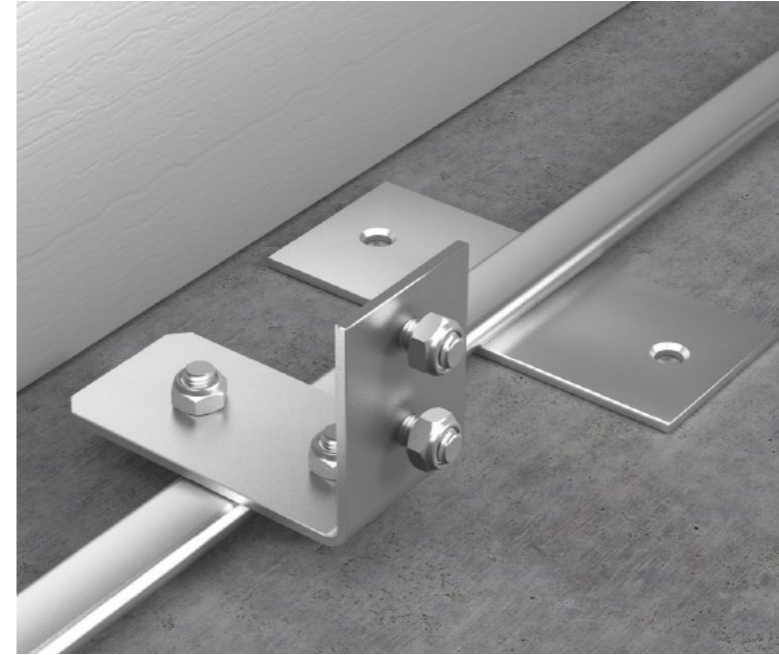

Floors are shimmed and fixed to cater for higher loads than non-fixed systems, but still allowing relocation at a later date. Suitable for floors with an average flatness of 15mm over the floor. Floors with levels outside this will need additional shims or consideration should be made to improve the floor prior to fitting the track. For example screed or a false structural floor. An infill floor is fitted, ensuring a smooth trip free floor surface between tracks. Alternative finishes can be supplied. Ramps and trim are fitted to all edges of the floor.



FLAT FLOORS TRACKLESS

A guide rail attached to the floor along the wall guides the carriages in perfect alignment. This removes the need for fixed tracks, leaving clear unobstructed aisles, reducing trip hazards and interference for trolleys or steps. Mobiles run on non-marking, polyurethane-rimmed ball-bearing wheels.

UP TO 100% SPACE SAVING

PROBE KINETIC 2+ MOBILE SYSTEM
Here are two examples of shelving covering the same area. The New Probe Kinetic 2+ Mobile Shelving System increases shelving real estate by as much as 100% for a given area.

Probe reserve the right to alter design and price without prior consent.



STOCKRAX STANDARD DUTY

Features & benefits

- Simple and quick **tap together** construction
- Offers **unrestricted access** from all sides
- Bays assembled within **ten minutes**
- Fully adjustable shelving for **speedy adaptability**
- Maximum bay loading - **2000kg UDL** for 1980mm high bays

maximum bay loading* **2000kg UDL**



*dependent on specification



Many heights, widths and depths available, please enquire.

Individual shelf loading up to **360kgs UDL** dependent on specification

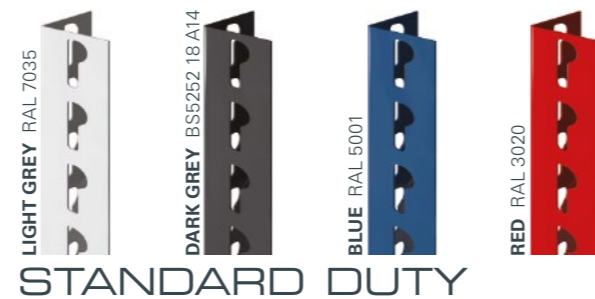

STANDARD DUTY

STOCKRAX HEAVY DUTY

Features & benefits

- Maximum bay loading **3000kg UDL** for 1980mm high bays
- Simple and quick **tap together** construction
- **Wide range of widths and depths** available for maximum flexibility
- Offers **unrestricted access** from all sides
- Bays assembled within **ten minutes**
- Fully adjustable shelving for **speedy adaptability**

maximum bay loading* **3000kg UDL**



Many heights, widths and depths available, please enquire.

Individual shelf loading up to **650kgs UDL** dependent on specification

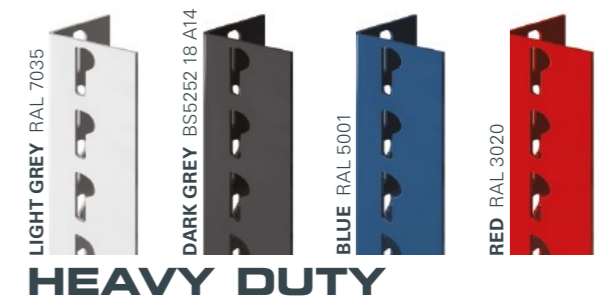

HEAVY DUTY



LONGSPAN SHELVING

Ideal for automotive parts storage but equally suitable for other industries requiring a storage solution for larger heavier items.

maximum bay loading:

6800kg

dependent on specification

Many heights, widths and depths available, please enquire.

Individual shelf loading up to **780kgs UDL** dependent on specification

Features & benefits

- Ideal for **larger, heavier** items
- Shelves are slotted in position for **quick assembly**
- An **extremely sturdy** and robust shelving system
- **Extension bays** can be added quickly and simply
- Available with **steel decks** for even **greater strength**
- **Many sizes available** to suit your heavy storage needs

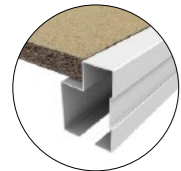

STANDARD DUTY STEPPED BEAM (2LST)

For use with 18mm thick chipboard. Lengths range from 1050mm to 3000mm.

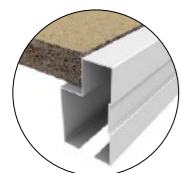

HEAVY DUTY STEPPED BEAM (4LST)

For use with 25mm thick chipboard. Lengths range from 1050mm to 3000mm.

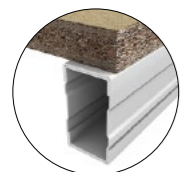

BOX EXTRA HEAVY DUTY BEAM (3LST)

For use with chipboard or steel panels. Lengths range from 1050mm to 3000mm.



BEAM CONNECTOR (SC1)

Beam Locking Clip. This ensures a safe and positive location of the beam.

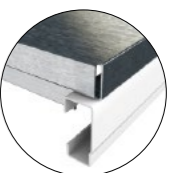

C SECTION MEDIUM DUTY BEAM (2LSC)

For use with 25mm thick chipboard. Lengths range from 1050mm to 3000mm.

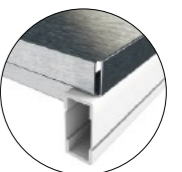

BOX EXTRA HEAVY DUTY BEAM (2LBC)

For use with chipboard or steel panels. Lengths range from 1050mm to 2400mm.

Many heights, widths and depths available, please enquire.

Individual shelf loading up to **780kgs UDL** dependent on specification



EUROSHELVING SHELVING

maximum bay loading: **5500kg**

dependent on specification

Many heights, widths and depths available, please enquire.



Can be stacked up to four bays high!

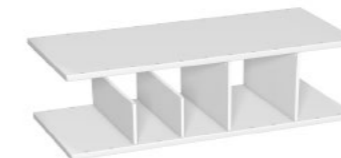

STANDARD SHELF

Each bay comes complete with 6 shelves. Additional shelves can be purchased separately.
Shelf loading:
300, 400 & 450mm shelves - UDL 160kg
600mm - UDL 135kg

PULL OUT SHELF

These pull out shelves provide a flat and stable work surface.
Width: 1000mm
Depth: 450mm
600mm

PULL OUT FILING CRADLE*

These cradles can accommodate A4 and foolscap top loading suspension files.
Width: 1000mm
Depth: 450mm
600mm

*hanging files not included.

PULL OUT DRAWER

Fitted onto telescopic arms, these 150mm deep pull out draws are ideal for CD and DVD storage.
Width: 1000mm
Depth: 450mm
600mm

DIVIDERS

A range of part height and full height shelf dividers are available, see price guide for all options.

PLASTIC DRAWER UNITS

Available in three sizes and ideal for the storage of small items. The drawers tilt on integrated back-stops to allow easy viewing and access.

KINETIC 2+



STORMOR SOLO



STORMOR DUO



STORMOR MONO



EUROSHELVING



STOCKRAX
STANDARD DUTY



STOCKRAX
HEAVY DUTY



LONGSPAN

